

duo

ready for compact flexibility



ENGEL
be the first

The bigger the requirements, the more sophisticated the solution. The **ENGEL duo** is compatible with any one of your concepts. Thanks to its extremely **flexible layout** and its **compact dimensions**, any machine of the ENGEL duo series will fit in perfectly with your production. No matter whether you are manufacturing **large-volume parts**, highly complex parts for the **automotive industry** or components of **high-tech** products with a perfect surface: The ENGEL duo is **always ready for compact flexibility**.

More power on less space: The ENGEL duo stands out with its sophisticated, **compact machine concept**. **two-platen technology**, the perfectly designed **variable injection** unit and the **flexible drive design** allow generation of **ENGEL control units**, you can look forward to perfect results: to particularly **quick, safe and**

It allows you to manufacture even parts with **highest shot weights** on a **minimum footprint**. Its proven for a swift sequence of all processes. Thanks to the fast and failure-free operating using the **CC300**, the newest **energy-efficient manufacturing**, as well as excellent **part quality**.

ENGEL duo clamping unit

- two rigid cast iron plates
- tie-bars without contact with the moving platen and with short-stroke pressure pads
- excellent platen parallelism
- the fastest two-platen machine
- high energy efficiency

ENGEL duo injection unit

- short design, two parallel hydraulic injection cylinders
- efficient screw drive
- drive with increased efficiency
- optimum guidance
- countless combinations available in the standard configuration

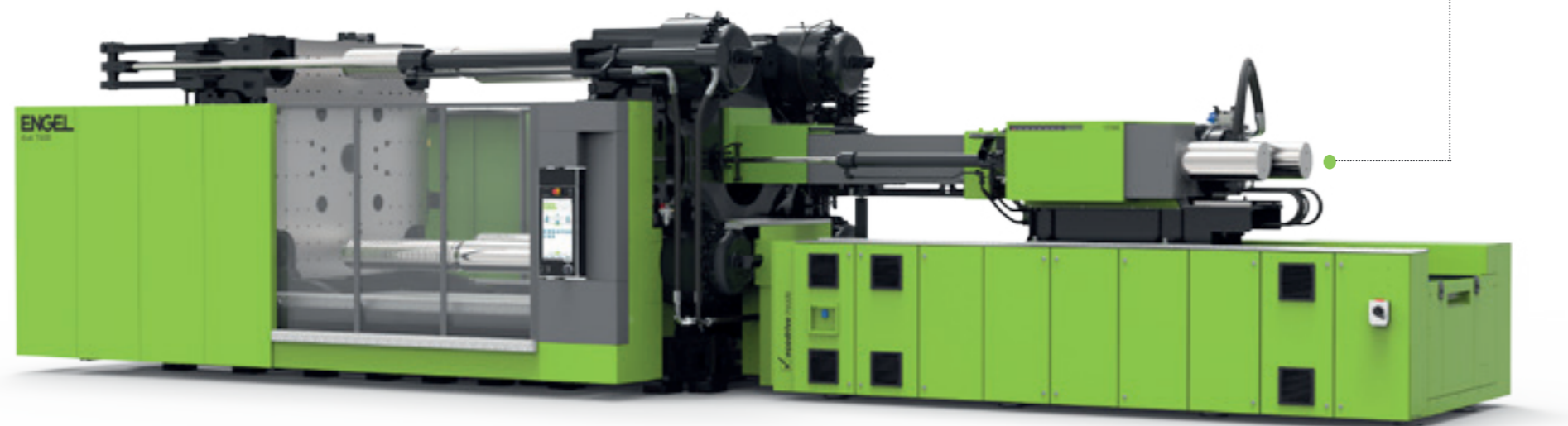

ENGEL duo clamping unit

compact, flexible, fast, energy-efficient



short stroke cylinder

high clamping force
rapid pressure build-up time
improved energy balance

tie-bars without contact with the moving platen

excellent mould protection
zero friction
clean mould area
tried and trusted system

two rigid cast iron plates

excellent rigidity
fastest dry cycle times
easy access to ejector

synchronised locking

quick & precise
short locking time

linear or sliding guide

perfect platen support
precise mould guidance & platen parallelism
energy-efficient mould movement



You need a **flexible production cell** with minimum space requirements: The **ENGEL duo** with its individually configured **two-platen clamping unit** is the **proven solution**. Its **compact design with a stable, low-friction platen guidance on carriages ensures optimum platen parallelism** and **sensitive mould protection**. This guarantees a **high level of operational safety** and **perfect part quality**.



Flexible machine layout

The ideal machine for any task: The ENGEL duo is designed to enable optimum guidance of all media supply lines within the clamping unit, especially towards the moving platen. This ensures maximum flexibility in configuring, re-adapting or expanding your production cell.

Improved clamping force

Whether 3500 or 55000 kN: Thanks to a narrow graduation of clamping unit sizes, the ENGEL duo series allows you to choose exactly the machine type, which will deliver optimum results. The clamping unit ensures an effective and quick clamping force build-up with four short pressure pads. iQ clamp control and wide + extra wide platen options enable smart and cost-efficient manufacturing of larger parts.

Trouble-free production

Fast movements and positive locking - extremely short dry cycle times: The ENGEL duo employs a synchronously controlled, maintenance-free locking which reaches particularly quickly and precisely into the tie-bars' ring groove. Since the tie-bars have no contact with the moving platen, there is no friction and this saves energy with every movement.

Maximum cost effectiveness

The ENGEL duo impresses with its energy-efficient, sustainable design. For example, it minimises pressure levels during movements by means of a smart hydraulic drive system. Furthermore, the moving platen is optimally supported and guided on carriages. The result: improved precision guiding even with heavy moulds, minimum mould wear and perfect mould protection, enabling you to keep your maintenance costs low at all times.

ENGEL duo injection unit

Compact, precise, energy-efficient

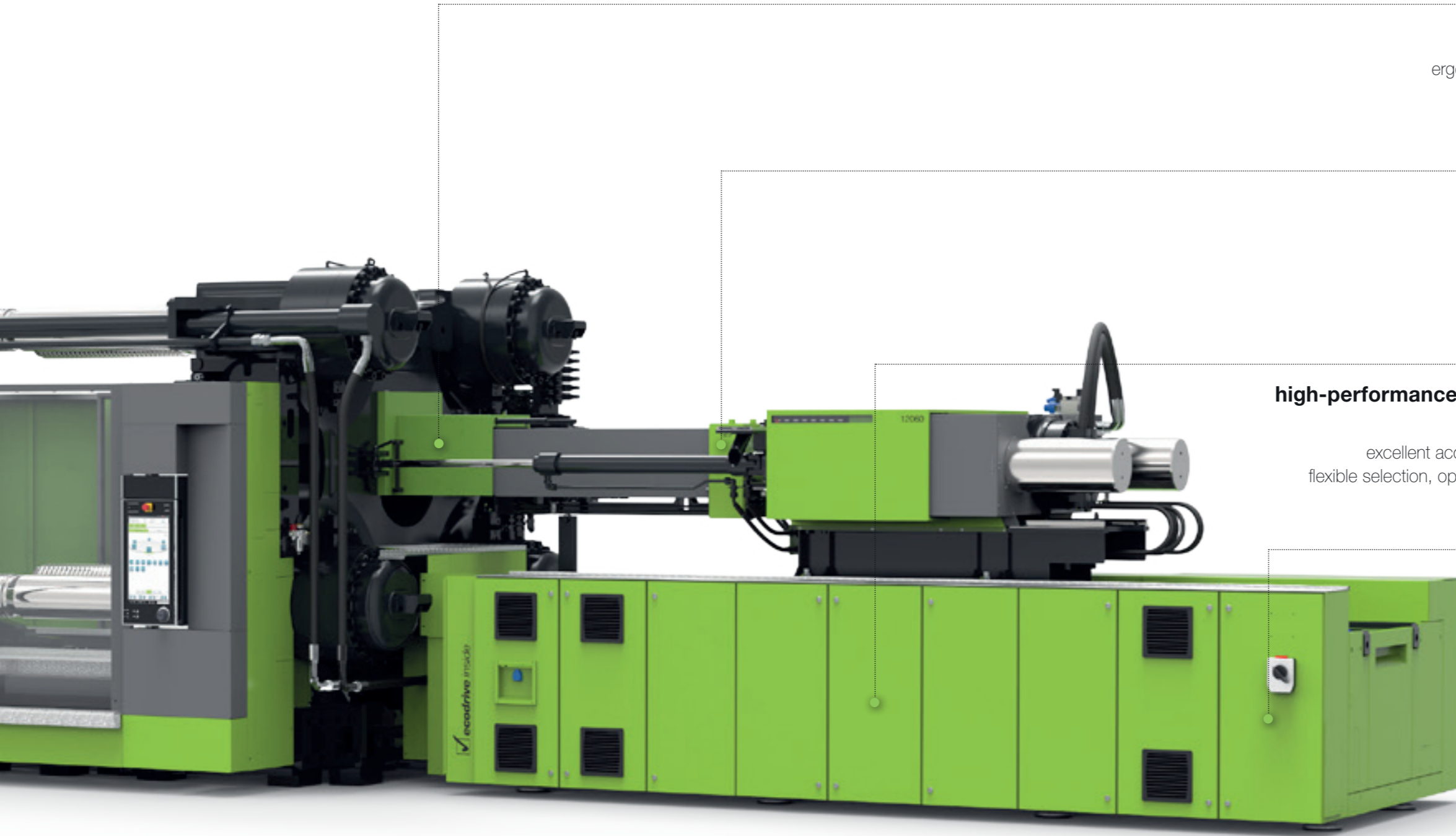

Ergonomics

ergonomic machine design
small footprint
fast barrel changes

Precision

precise injection
high level of process stability
iQ weight control (optional)

high-performance drive technology

high level of efficiency
excellent acceleration of movements
flexible selection, optimised for requirements

Efficiency

high plasticising performance
short set-up times
optimum accessibility of injection moulding area

Compact size - more space for your ideas: For multi-colour or multi-component applications, the ENGEL duo lets you easily arrange several **injection units side by side or vertically**. The **smart, variable concept** of the **ENGEL duo injection unit** flexibly adapts to your needs, always ensuring **precise and energy-efficient** production. Optimum machine sizes and corresponding performance characteristics such as injection pressure, injection speed and plasticising performance are perfectly aligned to present and future requirements.



High plasticising performance and process stability

The injection units offer high plasticising performance and consistent process stability. These are provided in equal parts by temperature and pressure control in the barrel: sticking in the feed section and the uptake of moisture are safely ruled out. This concept minimises loss of energy when cooling as well as when heating the crossbar.

high degree of process integration

Changes in ambient conditions, in raw materials, or in wear, affect component quality and may require a readjustment of the parameters. The iQ weight control software makes it possible to automatically recognise these deviations and compensate for them in the same shot. Rejects can thus be drastically reduced and productivity can be significantly increased.

short set-up times

Optimal ergonomics support the machine operator as well as the maintenance engineer. When swapping barrels, the removed barrel can be placed outside of the machine with no further mechanisms required. The barrels have been equipped with a stable stand for this purpose. The installation and removal of the barrel requires no special tools, thus speeding up the process and reducing downtime.

Energy efficiency

ecodrive - The ENGEL servo-hydraulic, tried and tested over many years, is part of the standard equipment package. The key to a high level of energy efficiency is the needs-based performance of the pump. While the machine is idle, during cooling phases for example, the drives are also stationary and do not use any energy. This has the positive side effects that the machines operate a lot more quietly, and that the hydraulic oil becomes less heated, which in turn also reduces the amount energy required for cooling the oil. The rotation of the drives is adjusted according to the required speed. The integrated software ensures an optimal duty point of the regulating pump, which helps to achieve the best overall efficiency factor.

Flexible drive

More efficiency with the perfect drive: The standardised, flexible concept of the duo matches the drive to the size of the machine. This ensures consistently short dry cycle times - independent of the size of the injection unit. Meanwhile, with its integrated pressure and volume control, the proven dual-cycle hydraulic system ensures parallel operation of all secondary movements.

ENGEL duo drive technology

hydraulic, flexible, quiet, energy-efficient

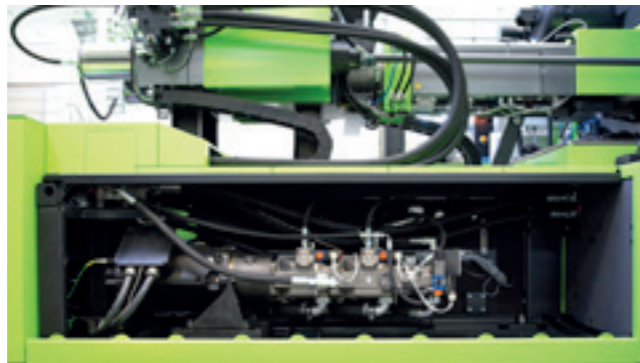

perfect sound insulation

Lambda-Quarter-damper
encapsulated motor pump assembly
flexible hoses replace conventional pipes

intelligent production

high, drive performance installed
options easily retrofitted
service-friendly machine concept

adjustable power control

modular motor pump unit with volume pressure control
using maximum motor power at highest speeds

combinable modules

plasticising injection units with drive performance between 45 and 550 kW
motor pump combination units complete with hydraulic switching elements selectable
variants with increased drive performance
concepts for best precision

economical consumption

efficient energy-saving hydraulics
consumer pressure dependent oil volume flow
flexible control of pump capacity

ENGEL ecodrive (plus*)

excellent energy efficiency
substantially lower cooling water requirements
extremely low noise level
working point optimisation for best energy efficiency factor
* electric screw drive (optional)

The Options

A **trouble-free and safe production** requires perfect support. How convenient that everything required can be obtained **from a single source**: With **ENGEL's perfectly designed options**. This allows you to keep **set-up, service and maintenance** of your manufacturing unit as well as **manufacturing logistics** perfectly under control. And well-targeted **energy management** of your machine offers further opportunities to reduce costs.

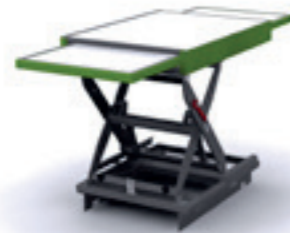

ENGEL tie-bar retraction device

Over-sized moulds and low ceiling heights: The ENGEL tie-bar retraction device enables overhead mould change of even large moulds quickly (in as little as 45 seconds) and without removing core cylinders and slides. This device automatically retracts one of the upper tie-bars – within the machine footprint – in direction of the injection unit, saving space by doing so. After setting the mould the tie-bar is quickly retracted into position for production.

ENGEL lifting platforms

For more safety and convenience: ENGEL lifting platforms facilitate set-up and repairs in the mould area of injection moulding machines, and offer additional safety. Their lifting mechanism and the pneumatically extendable side tables can be controlled easily and safely via a hand control device.

ENGEL service platforms

Maintenance and service made easy: Thanks to their variable stairway, ENGEL service platforms enable best possible access to the injection unit. This way, work in this area, such as material feeding or barrel change can be carried out safely and conveniently.



ENGEL mould parallelism test

The perfect software for optimum process quality: The ENGEL mould parallelism test determines the exact position of all four tie-bars under clamping force as well as during injection. The position measurement is carried out by means of high-resolution stroke transducers and is able to recognise and display deviations as small as 50µm. This allows you to compare dimensions and carry out process-compliant optimisations of the clamping force on this basis.

ENGEL famox

Ready for action in just a few sections: ENGEL famox helps you to reduce set-up times and thus increase plant productivity. Apart from high mould changing speeds, it impresses with its integrated mould preheating station, the standardised multi-coupling for media lines, and the robust, permanently available direct roller drives. This smart mould changing system is connected via an interface to the new ENGEL CC 300 machine control unit and therefore enables the simultaneous exchange of all mould and machine parameters.

ENGEL ecobalance

The intelligent power management software for the entire plant: ENGEL ecobalance eliminates energy peaks in a targeted manner. During the machine's warm-up phase the system ensures that available energy is used entirely for heating and only excess energy reserves are used to preheat oil in the drive unit. If the energy limit is exceeded during production, the capacity of the barrel heating unit is cleverly distributed or, if necessary, temporarily reduced.

Sophisticated, compact **machine concepts** from 3,500 kN to 55,000 kN

Whether large-scale parts, demanding components for the automotive industry of high-tech products with perfect surfaces: The **ENGEL duo** fits in nicely with your production, thanks to its **flexible, modular machine layout** and its compact **outer dimensions**.

Subject to change!

ENGEL duo			1060		1560			2460			3660			5160			8160			12060			17060			23060			35050			45050			55050			75050			100050			130050		
			50	55	60	55	60	70	60	70	80	70	80	90	80	90	105	90	105	120	105	120	135	120	135	150	135	150	170	160	170	180	180	190	200	190	200	215	215	230	245	230	245	260	260	
	kN	US tons																																												
ENGEL duo 350	3,500	400																																												
ENGEL duo 400	4,000	440																																												
ENGEL duo 450	4,500	500																																												
ENGEL duo 500	5,000	550																																												
ENGEL duo 550	5,500	610																																												
ENGEL duo 600	6,000	660																																												
ENGEL duo 650	6,500	720																																												
ENGEL duo 700	7,000	770																																												
ENGEL duo 800	8,000	900																																												
ENGEL duo 900	9,000	1,000																																												
ENGEL duo 1000	10,000	1,100																																												
ENGEL duo 1100	11,000	1,250																																												
ENGEL duo 1300	13,000	1,460																																												
ENGEL duo 1500	15,000	1,650																																												
ENGEL duo 1700	17,000	1,900																																												
ENGEL duo 2000	20,000	2,200																																												
ENGEL duo 2300	23,000	2,500																																												
ENGEL duo 2700	27,000	3,000																																												
ENGEL duo 3200	32,000	3,500																																												
ENGEL duo 4000	40,000	4,400																																												
ENGEL duo 5500	55,000	6,000																																												

ENGEL duo WP			2460		3660			5160			8160			12060			17060			23060			35050				
	kN	US tons	60	70	80	70	80	90	80	90	105	80	105	120	105	120	135	120	135	150	135	150	170	135	150	160	
ENGEL duo 600	6,000	660																									
ENGEL duo 700	7,000	770																									
ENGEL duo 900	9,000	1,000																									
ENGEL duo 1100	11,000	1,250																									
ENGEL duo 1500	15,000	1,650																									
ENGEL duo 1700	17,000	1,900																									

ENGEL duo WPX			2460		3660			5160			8160			12060			17060			23060			35050				
	kN	US tons	60	70	80	70	80	90	80	90	105	80	105	120	105	120	135	120	135	150	135	150	170	135	150	160	
ENGEL duo 500	5,000	550																									
ENGEL duo 700	7,000	770																									
ENGEL duo 900	9,000	1,000																									
ENGEL duo 1100	11,000	1,250																									

ENGEL **e-duo** all-electric

In case the **production of parts** calls for extremely high precision: The **ENGEL e-duo** combines the **power and flexibility** of our successful two-platen large-scale machine with the utmost **precision and energy efficiency** of our proven electric drive technology. Apart from the clamping force-build-up, the ENGEL e-duo's drive axles are all-electric. This way you can manufacture especially parts with long flow paths in a manner to satisfy your demands for **quality and cost efficiency**.

- compact **manufacturing cell**
- tried and tested **two-platen concept**
- **precision** independant of media (e.g. oil)
- perfect **reproducibility**
- superior **energy efficiency**
- flexible mould fixing area
- high **injection performance**
- smooth **linear guidance**

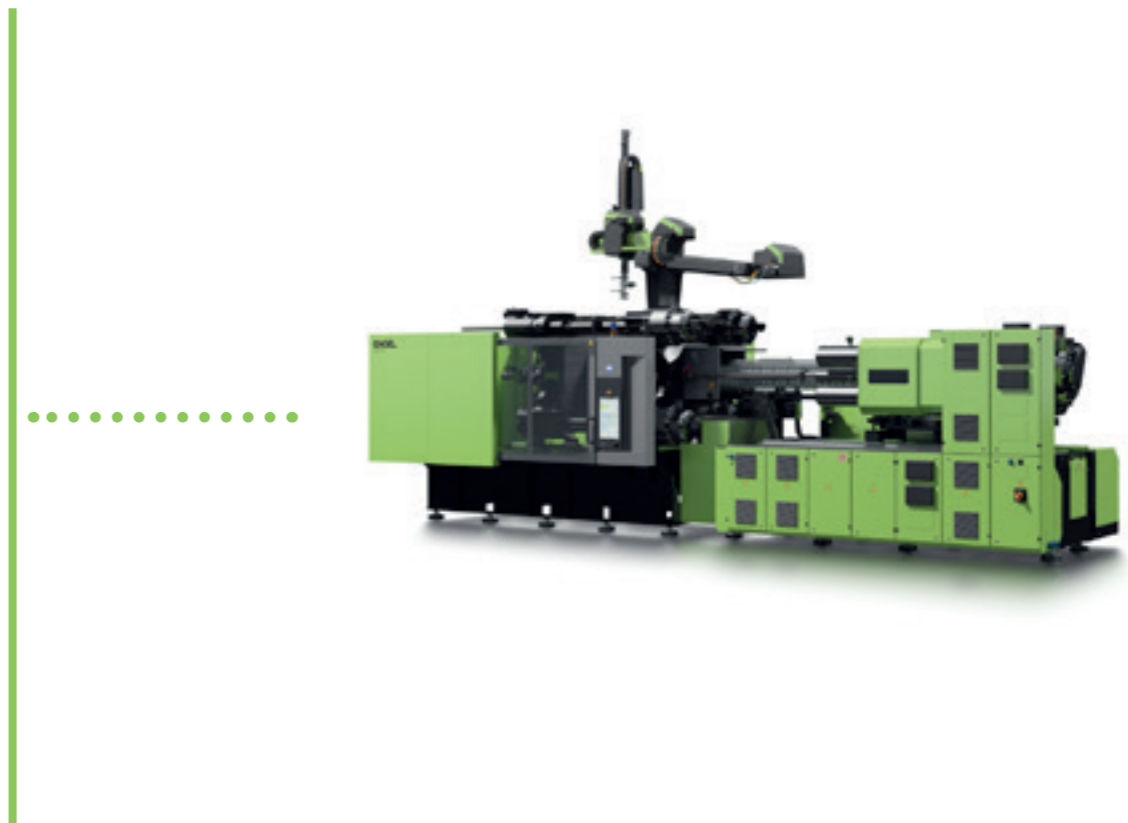

ENGEL **e-duo** all-electric

Efficient manufacturing

The ENGEL e-duo stands for maximum efficiency: Its small size saves space and its intelligent drive concept saves energy. Since all important components are servoelectric, the e-duo can reduce its energy consumption by up to 50% compared to a standard ENGEL duo. Furthermore, this machine uses less hydraulic oil & cooling water and requires low maintenance costs.

High productivity

More dynamics for precise, large parts: The ENGEL e-duo is extremely fast. The desired performance is achieved thanks to an injection speed of up to 450 mm/s, very fast clamping unit movements, and an integrated servo-hydraulic system for parallel operation of the core pulls.

Precise quality

No matter whether high clamping forces or high injection performances are required: The ENGEL e-duo always delivers an incomparably precise result in demanding applications. Its perfect platen parallelism, its intelligent contact force system with exactly adjustable contact force and nozzle movement, as well as the force introduction via two symmetrically arranged spindles open up new dimensions in high-sensitive manufacturing of large premium parts.

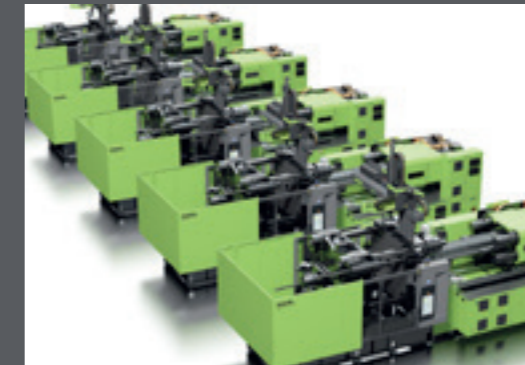

ENGEL v-duo

The future of the automotive industry lies in **lightweight construction**: The newly developed **ENGEL v-duo** is ideally equipped for this purpose. This **vertical large-scale** machine is a highly sensitive power house, which delivers extremely **precise results**, especially with **fibre composite applications** and **high cavity pressure processes**. What makes it so extraordinary: many **individual equipment options**, **high energy efficiency** and **compact size** - perfect if you want to use existing shop floor structures.



- compact, lightweight **manufacturing cell**
- tried and tested **two-platen concept**
- perfect **precision & reproducibility**
- high **energy efficiency**
- superior **accessibility**
- short **cycle times**
- flexible **manufacturing layout**

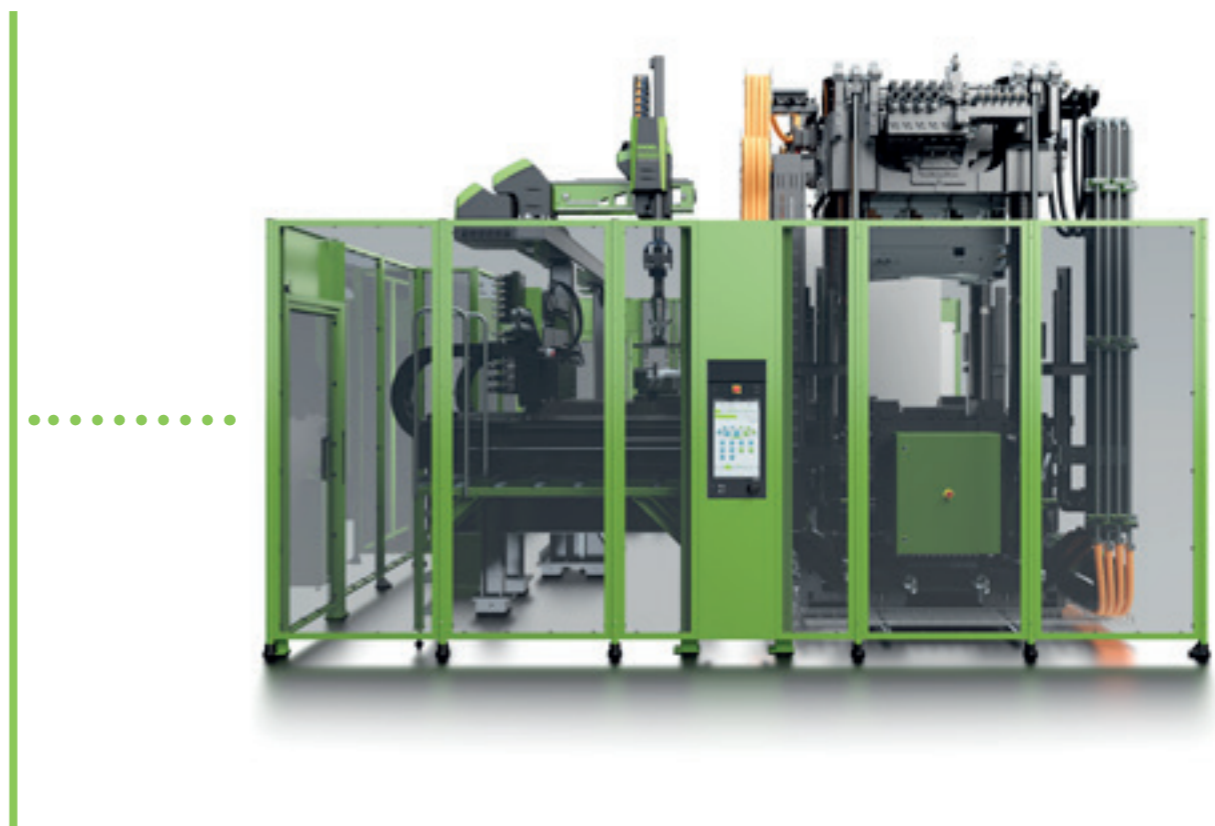

ENGEL v-duo

Space-saving precision

Low height, low weight, low footprint: The ENGEL v-duo is the compact large-scale machine for manufacturing high-precision parts which are both large-scale and lightweight. It uses the advantages of gravity and therefore facilitates e.g. inserting reinforcing elements, such as organic sheets or tapes. But also for HP-RTM processes the ENGEL v-duo is the perfect, flexible production unit.

Highest stiffness

More than a conventional vertical press: The machine is designed to guarantee optimum platen parallelism and maximum platen stiffness. The result: The wall thickness of the produced parts precisely fulfil the requirements.

Versatile manufacturing cell

Superior access and a high level of operating safety make the ENGEL v-duo perfect for any kind of automation. Whether sliding table, specialised equipment for reaction technologies or fully automated systems: It can be adapted exactly to your specific manufacturing needs any tim.

High efficiency

Efficiency is standard for the ENGEL v-duo: e.g. by employing our energy-saving option ENGEL ecodrive and dispensing with traditional hydraulic accumulators as a factory standard. Platen parallelism control for pre-compression processes ensure a precise manufacturing at high compression speed.

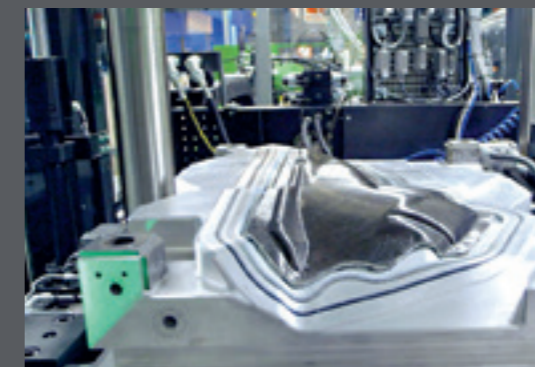
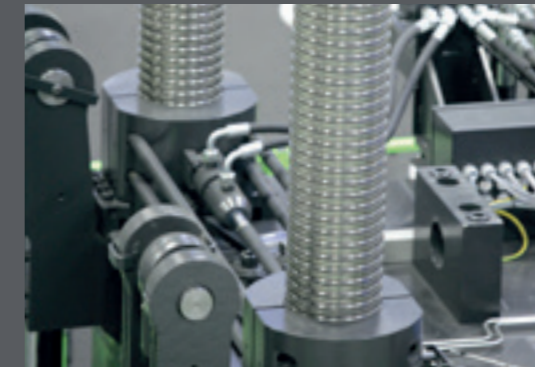

ENGEL technologies

Wherever plastics are used nowadays: The right **ENGEL technology refines** any **raw material** and adds **specific characteristics**, depending on the desired application. The ENGEL duo and our know how as **world market leader in injection moulding** makes PU, polyester, silicone and others fit for **your innovative ideas**. Therefore, we are constantly working to develop **new technologies together** with you. So you can rely on **efficient manufacturing, perfect surfaces** and **smart material combinations** and therefore **save weight and cost**.



combimelt - different materials combined with competence | **coinjection** - mastering cost & quality optimisation | **coinmelt** - injection compression moulding process for special requirements | **glazemelt** - combination of injection moulding for large, crystal-clear parts | **foammelt (MuCell®)** - precise lightweight parts made of microfoam structures | **dolphin** - soft-touch surfaces for multi-component parts | **tecomelt** - perfect trims for vehicle interior | **foilmelt** - smart surfaces & additional features thanks to foils | **clearmelt** - scratch-resistant top-quality optical moulded parts | **gasmelt/watermelt** - specific hollows & less material | **optimelt** - top-quality optical moulded parts | **x-melt** - highly efficient manufacturing of precise micro & thin wall parts | **organomelt** - lightweight plastic components as strong as steel | **LIM** - flexible processing of liquid silicone | reliable quality | **varysoft®** - extremely comfortable interior parts for the automotive industry | **PVC** - economic production with technology with duromer systems | **Duroplast BMC** - thermoset processing to the highest standards | **HP-RTM** - fibre-composite technology | **variomelt** - optimised surfaces thanks to targeted temperature control

tion | **coinmelt** - injection compression moulding process for special requirements | **glazemelt** - combination of injection moulding for large, crystal-clear parts | **foammelt (MuCell®)** - precise lightweight parts made of microfoam structures | **dolphin** - soft-touch surfaces for multi-component parts | **tecomelt** - perfect trims for vehicle interior | **foilmelt** - smart surfaces & additional features thanks to foils | **clearmelt** - scratch-resistant top-quality optical moulded parts | **x-melt** - highly efficient manufacturing of precise micro & thin wall parts | **varysoft®** - extremely comfortable interior parts for the automotive industry | **PVC** - economic production with technology with duromer systems | **variomelt** - optimised surfaces thanks to targeted temperature control

Innovative products and economic production
through the combination of materials



As a manufacturer of premium plastic materials, the requirements that you have to fulfil are constantly increasing. Combinations, additions, symbioses and alloys of materials are required for the precise achievement of desired multicomponent applications.

Combinations unite individual properties to form a stronger, more advantageous whole. ENGEL combimelt technology follows this principle and includes all known methods for combining plastics in injection moulding. Combinations of colours, shapes, functions, or alternative materials therefore become a reality.

A wide range of electrical and hydraulic ENGEL injection moulding units, alongside a variety of manufacturing processes, configuration options and automation solutions form the pool from which ENGEL can produce the optimal production cell, tailored to individual requirements.

combimelt process

Composite and combination injection moulding

In the simplest case – multi-colour injection moulding – the combined plastics differ only in colour, to create a specific design. This method involves the processing of different colours, of the same material, in an individual part. However, it is also often necessary to combine different material qualities in a given component. In these cases, the plastics should possess a common adhesive quality to guarantee that the components of the finished part are securely bonded.

Enhanced process

Enhanced processes are often necessary to fulfil requirements such as optimal process integration and high product quality. These design and quality requirements are important, for example, in modern vehicle manufacturing and medical technology.

Assembly moulding

Here the aim is to assemble individual components for assemblies or functional units, and not to produce individual multi-component parts. In this instance, the different materials are chosen based on their specific properties. Assemblies with moving individual parts or assemblies with integrated seals become possible.

combimelt **unit combinations**

in H/L position

- Ideal for larger shot weights
- Flexible, horizontal adjustability for mould parting line
- Can be retrofit on ENGEL victory, ENGEL e-victory, ENGEL e-motion, ENGEL duo

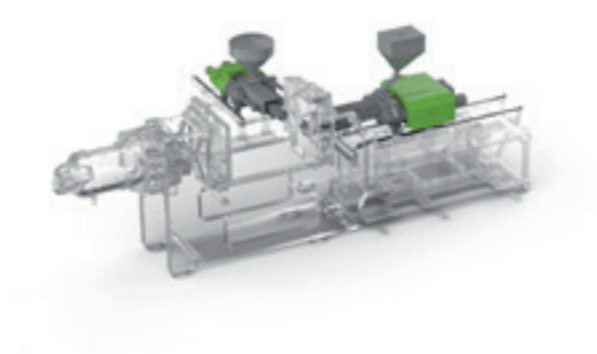

in H/V position

- Space-saving variant for smaller shot weights
- Available for ENGEL victory, ENGEL e-victory, ENGEL e-motion, ENGEL duo

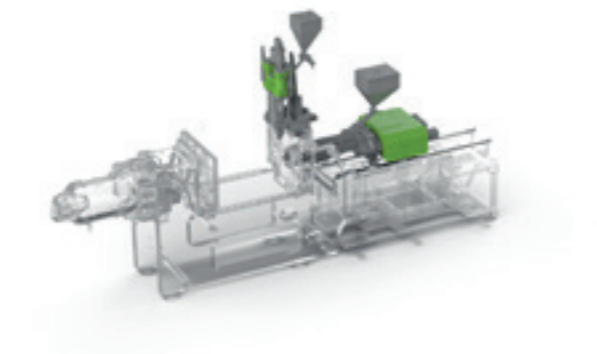

in H/W position

- Perfect for all automation solutions
- Low height
- Space-saving variant for small and medium shot weights
- Available for ENGEL victory, ENGEL e-victory, ENGEL e-motion, ENGEL duo

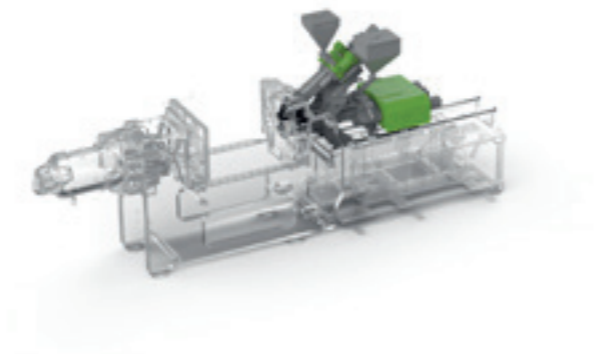

in H/H position

- Particularly short nozzle distance
- Two units with horizontal adjustability
- For rotary table units up to 2.5 m in diameter
- For ENGEL duo



in H/M position Combi M

- Unit on a stationary platen
- "Movable" unit on the moving mould mounting platen
- For rotary table units up to 2 m in diameter
- For ENGEL duo and ENGEL e-motion

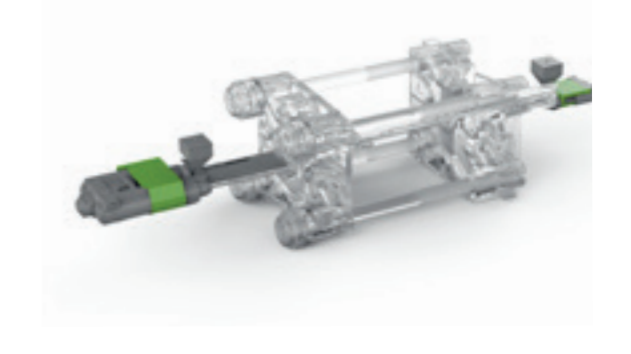

combimelt **Special variations**

- For up to 6 injection units
- For ENGEL victory, ENGEL e-victory, ENGEL e-motion, ENGEL duo

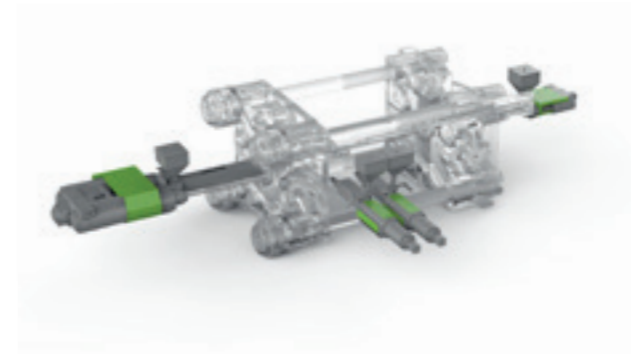

ENGEL combimelt

several injection units in standard combination & highly complex combined solutions

V-arrangement	200	330 - 650	750 - 1050
	injection unit V		
ENGEL duo 350-400			
ENGEL duo 450-500			
ENGEL duo 550-600			
ENGEL duo 650-700			
ENGEL duo 800-900			
ENGEL duo 1000-1100			
ENGEL duo 1300-1500			
ENGEL duo 1700			
ENGEL duo 2000-2300			
ENGEL duo 2700			
ENGEL duo 3200			
ENGEL duo 4000			
ENGEL duo 5500			

H/V arrangement
full flexibility with up to six injection units

L-arrangement	200	330 - 650	750 - 1050	1350 - 1800	2050 - 2550	3550 - 5550
	injection unit L					
ENGEL duo 350-400						
ENGEL duo 450-500						
ENGEL duo 550-600						
ENGEL duo 650-700						
ENGEL duo 800-900						
ENGEL duo 1000-1100						
ENGEL duo 1300-1500						
ENGEL duo 1700						
ENGEL duo 2000-2300						
ENGEL duo 2700						
ENGEL duo 3200						
ENGEL duo 4000						
ENGEL duo 5500						

H/L arrangement
for special applications

W-arrangement	200	330 - 650	750 - 1050	1350 - 1800	2050 - 2550	3550 - 5550
injection unit H	injection unit W					
750-1050						
1350-1800						
2050-2550						
3550-5550						
7050-11050						
16050-23050						
35050-45050						
55050						
75050-100050						
130050						

H/W arrangement
for particularly space-saving manufacturing

H/H arrangement
with particularly low nozzle distance

H-arrangement	210	600 - 1000	1300 - 1700	2000 - 2500	3500 - 4500	7000 - 11000	16000 - 23000	35000 - 45000	105000
	injection unit H								
ENGEL duo 350-400	160	400	450						
ENGEL duo 450-500	160	400	450	520					
ENGEL duo 550-600	160	400	450	520	650				
ENGEL duo 650-700	160	400	450	520	650				
ENGEL duo 800-900		400	450	520	650	750			
ENGEL duo 1000-1100		400	450	520	650	750			
ENGEL duo 1300-1500			450	520	650	750	900		
ENGEL duo 1700				520	650	750	900		
ENGEL duo 2000-2300				520	650	750	900		
ENGEL duo 2700						750	900	1100	
ENGEL duo 3200						750	900	1100	
ENGEL duo 4000							900	1100	1000
ENGEL duo 5500							900	1100	1000

H/M arrangement
ENGEL Combi-M with rotary table on a horizontal rotation plane for large-scale components on 2C-machines

M-arrangement	200	330 - 650	750 - 1050	1350 - 1800	2050 - 2550	3550 - 5550	7050 - 11050	16050 - 23050
	injection unit M							
ENGEL duo 350-400								
ENGEL duo 450-500								
ENGEL duo 550-600								
ENGEL duo 650-700								
ENGEL duo 800-900								
ENGEL duo 1000-1100								
ENGEL duo 1300-1500								
ENGEL duo 1700								
ENGEL duo 2000-2300								
ENGEL duo 2700								
ENGEL duo 3200								
ENGEL duo 4000								
ENGEL duo 5500								

Injection unit on the moving mould mounting platen
 Injection unit guided on clamping base

